

鋼製下地断熱防水 DIP S / HT 構法

パラペット 桁方向 / 鉄骨立上り

dhtas-1-1

1/10 (A4)

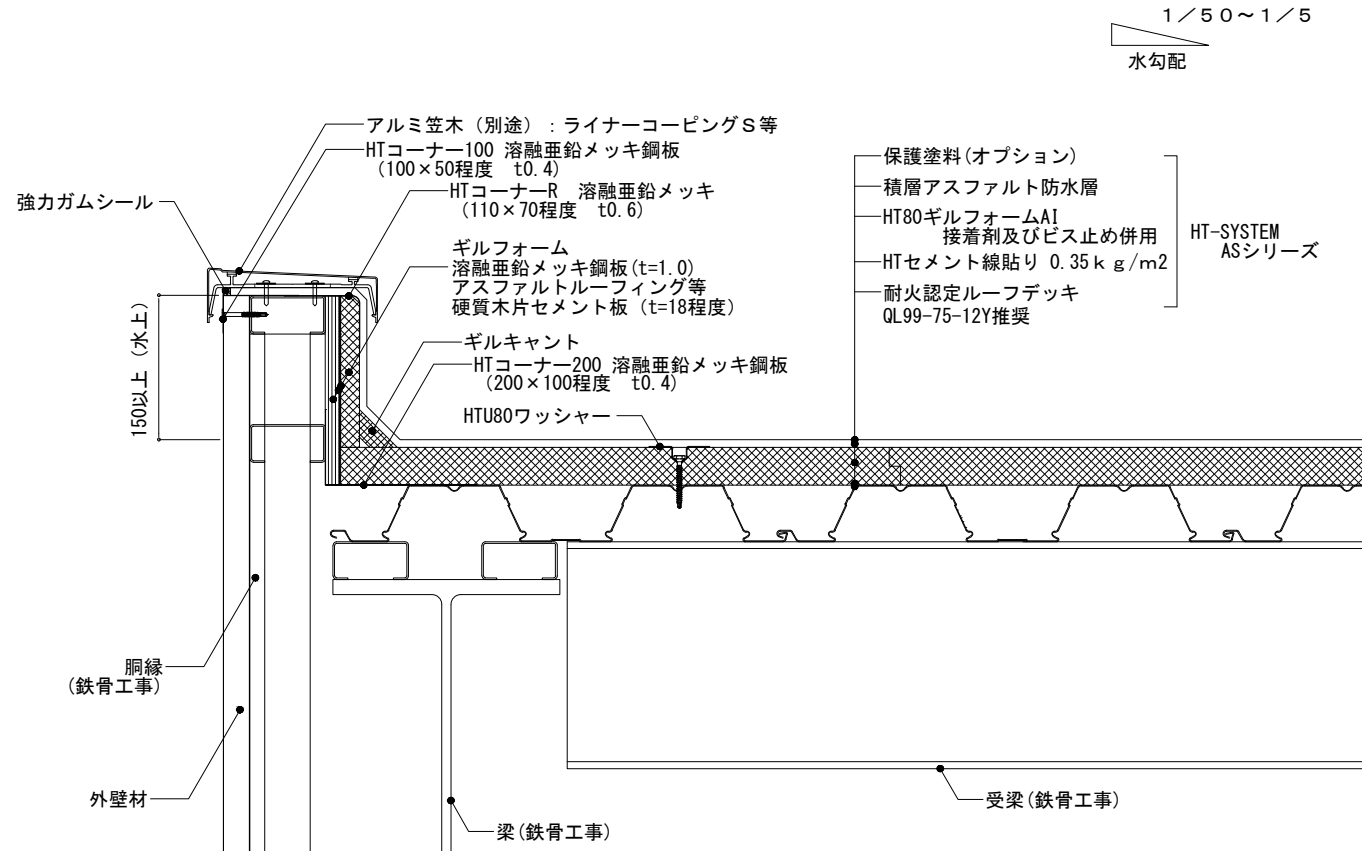

鋼製下地断熱防水 DIP S / HT 構法

パラペット 流れ方向 / 鉄骨立上り

dhtas-1-2

1/10 (A4)

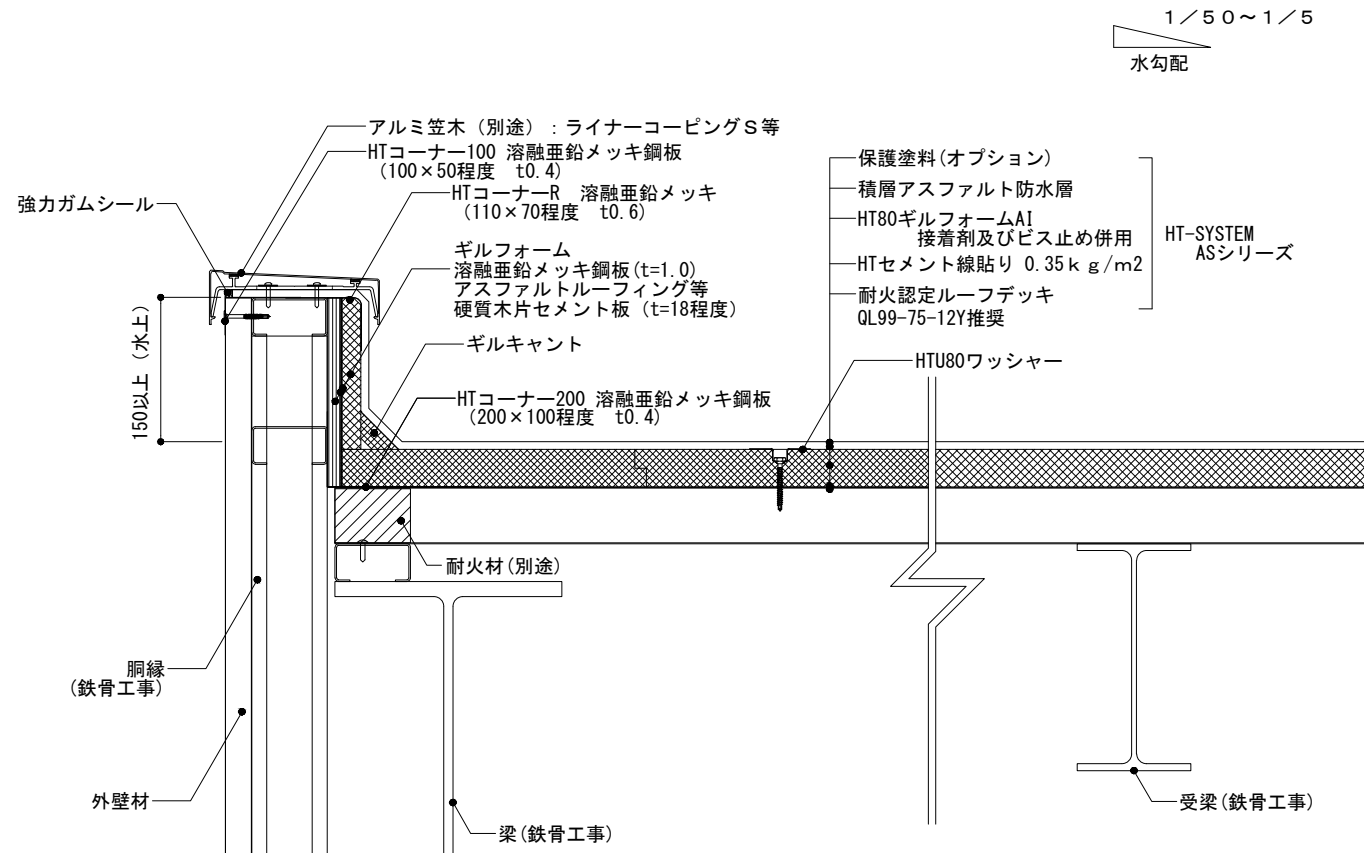

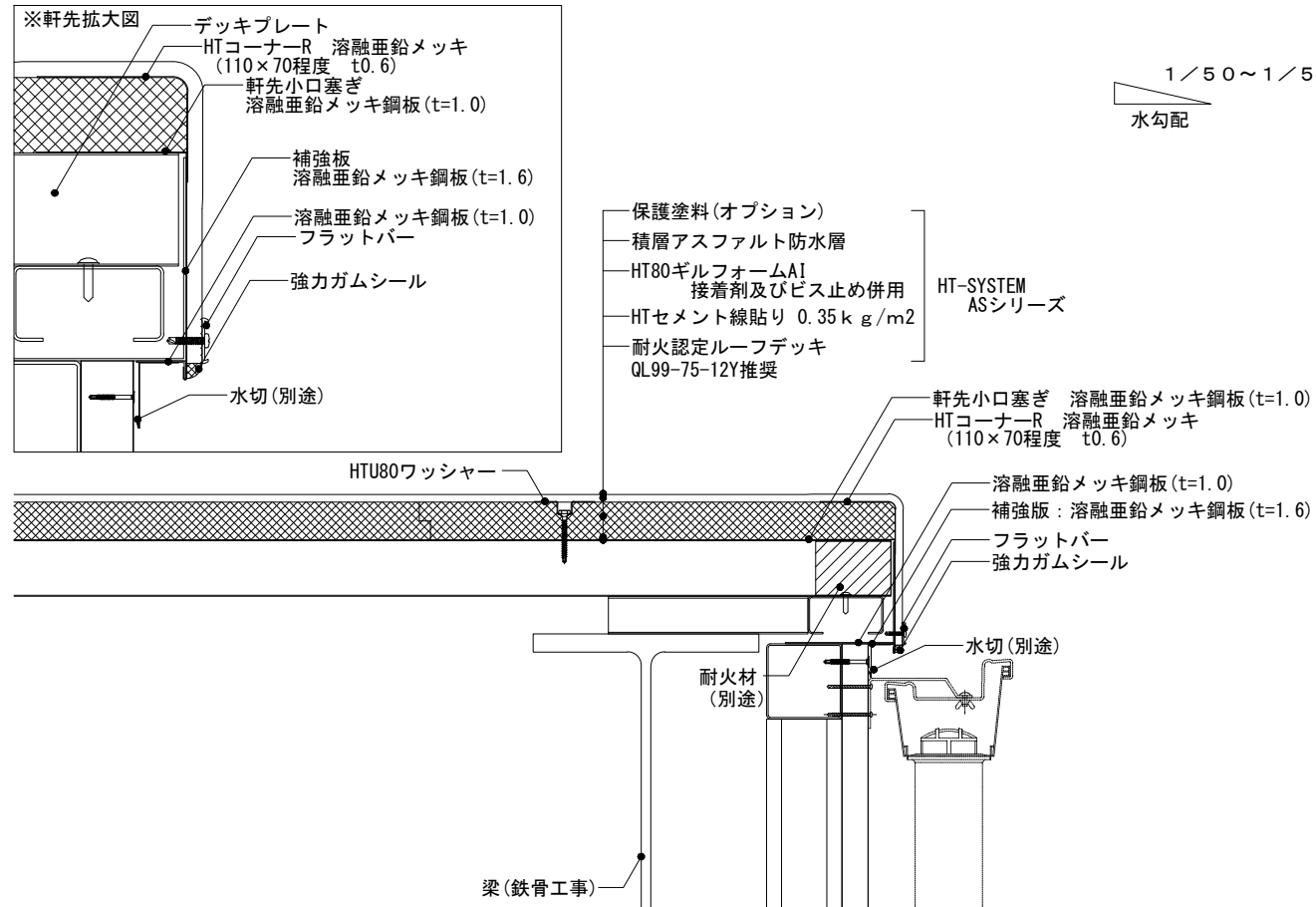

鋼製下地断熱防水 DIP S / HT 構法

壁立上り / ALC立上り

dhtas-1-4

1/10 (A4)

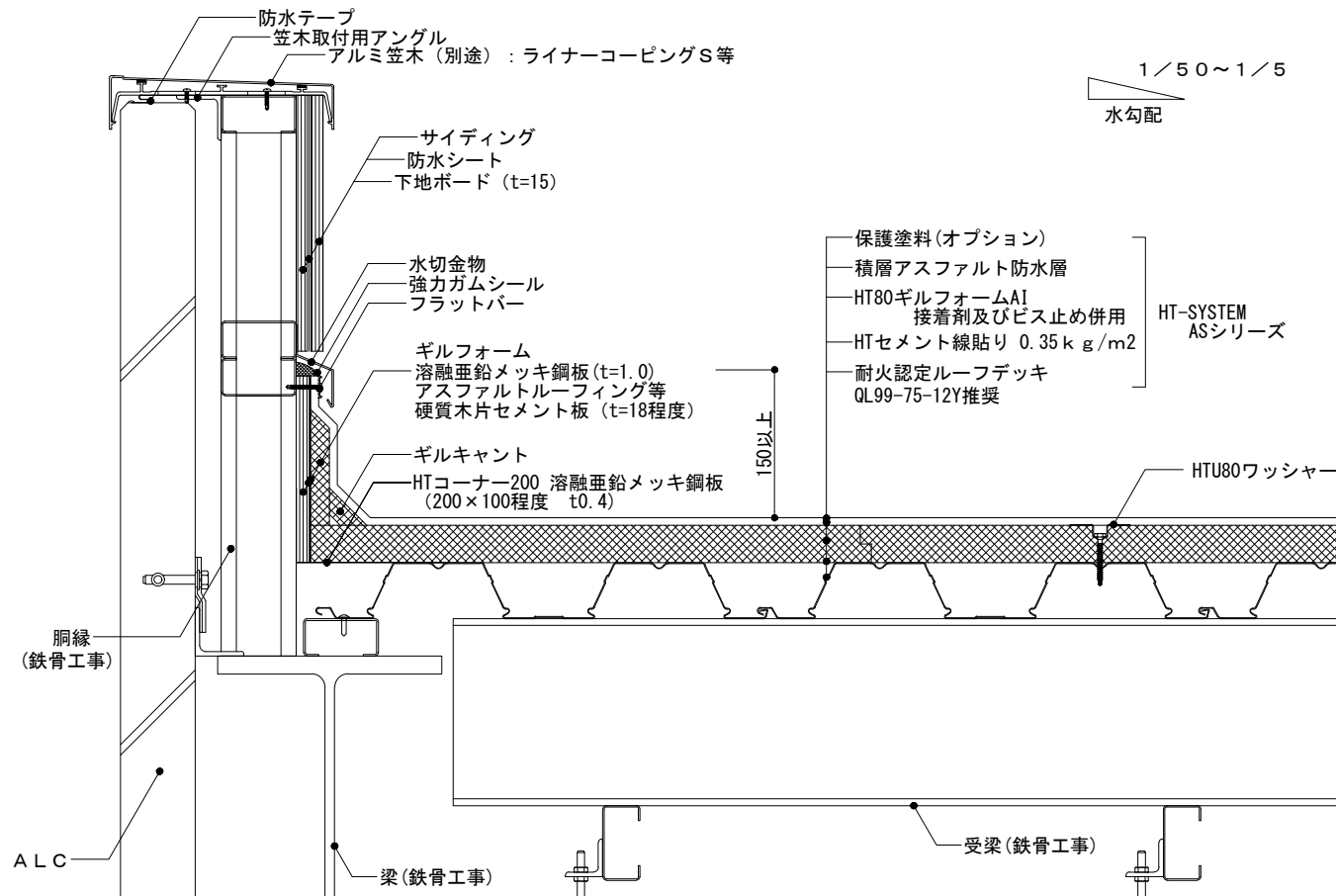

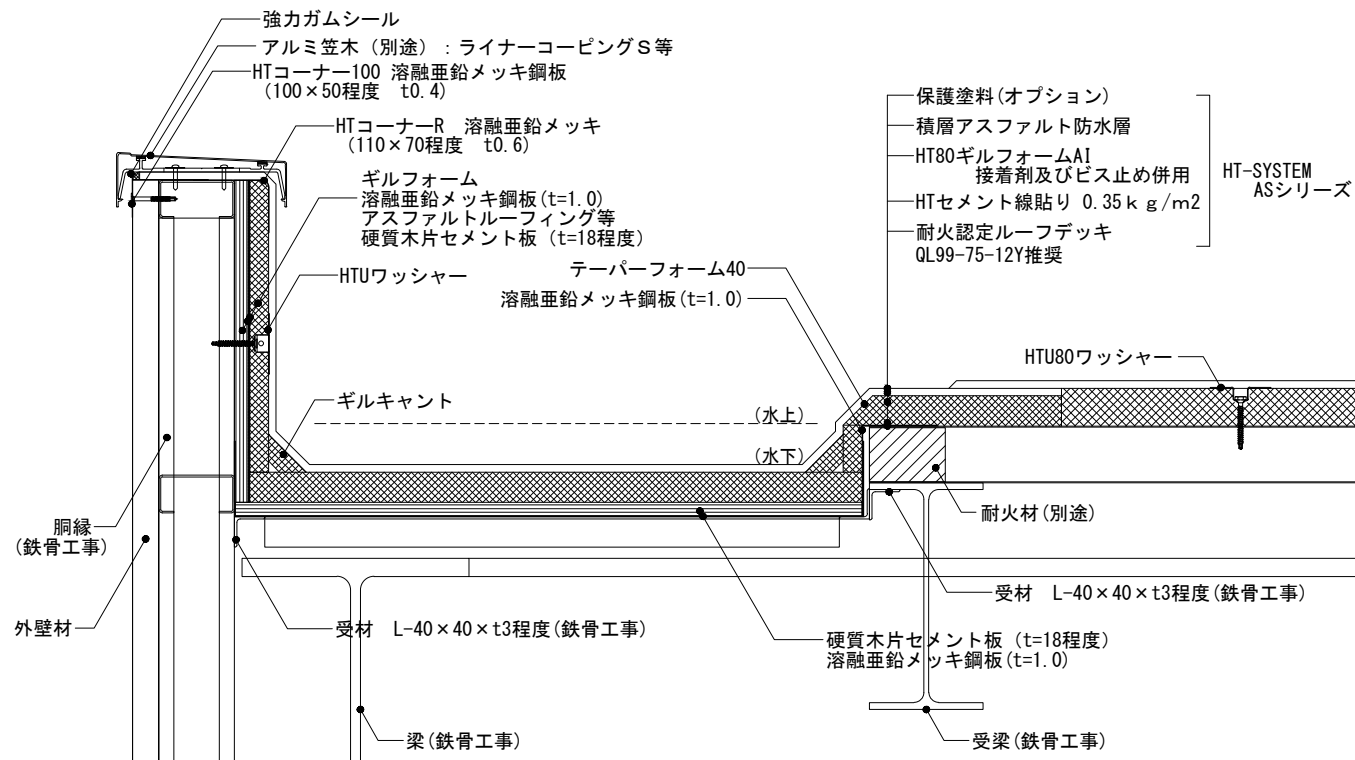

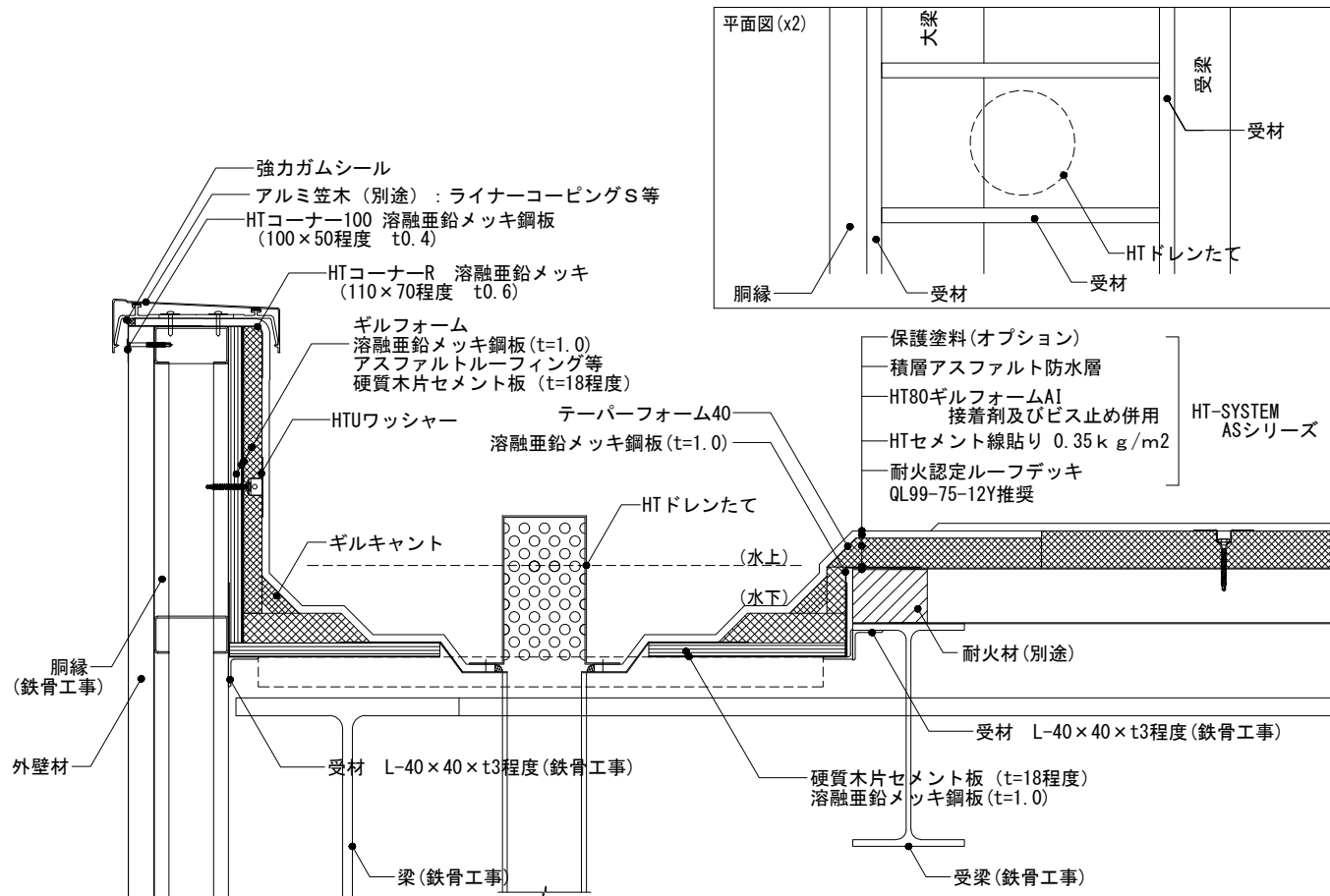

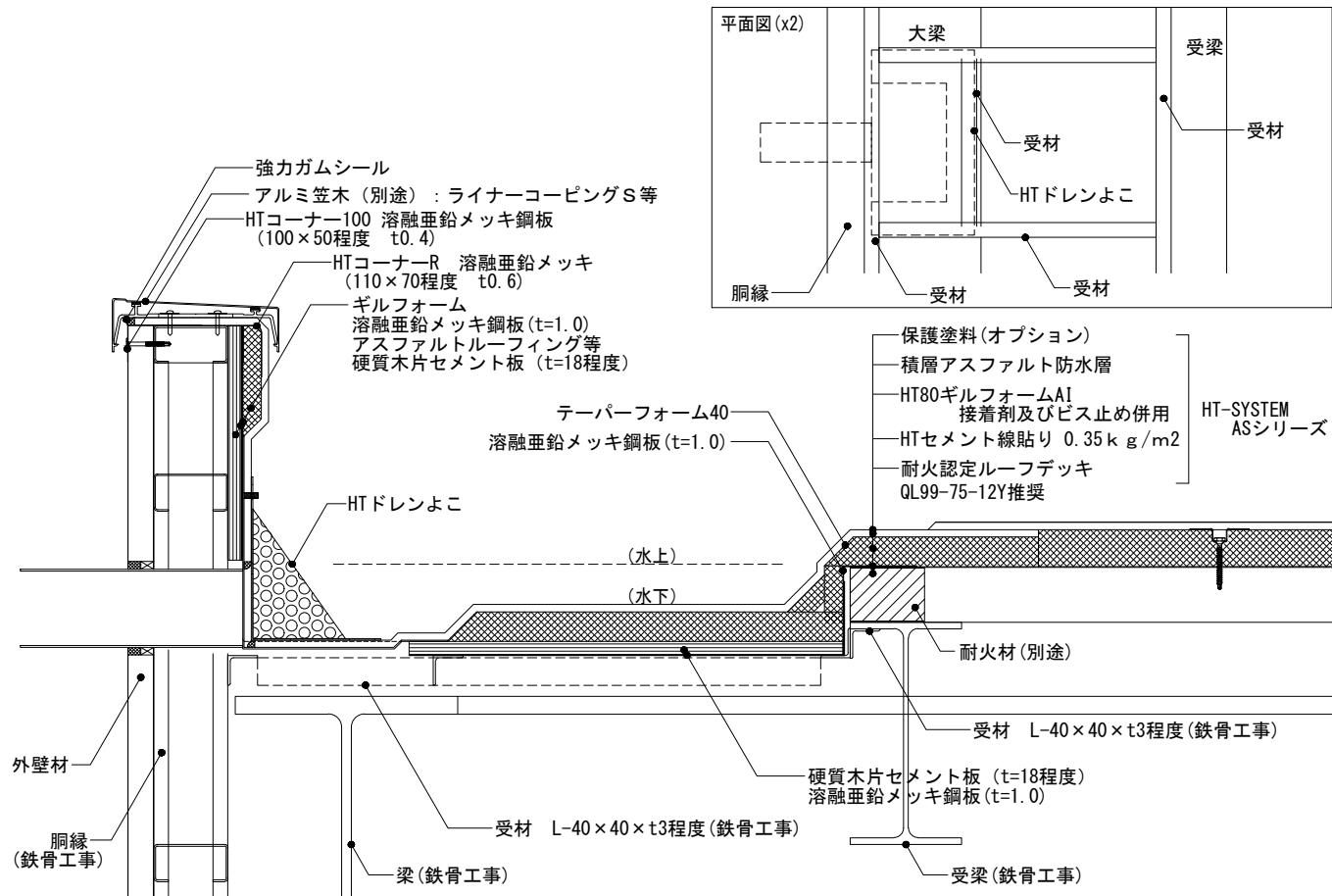

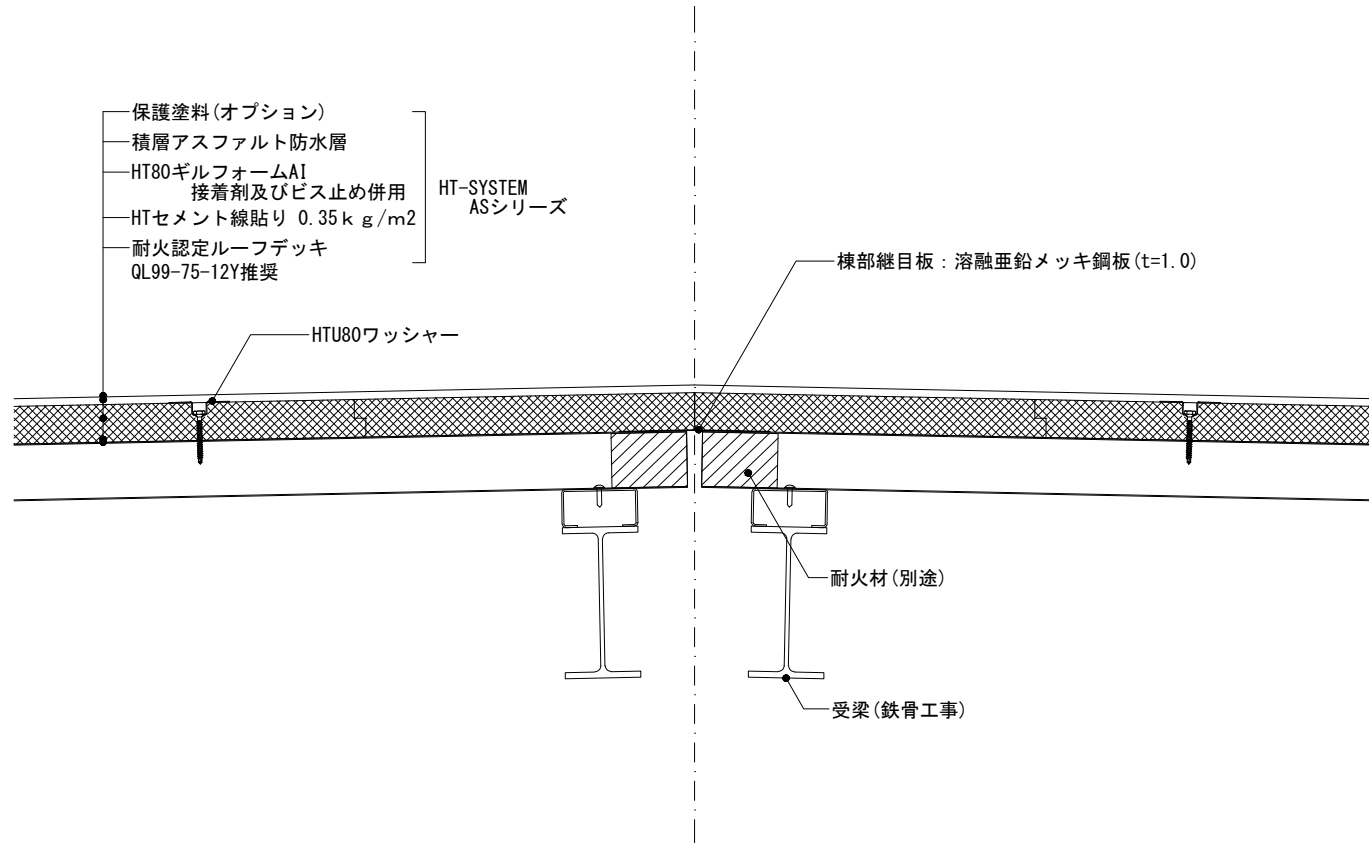

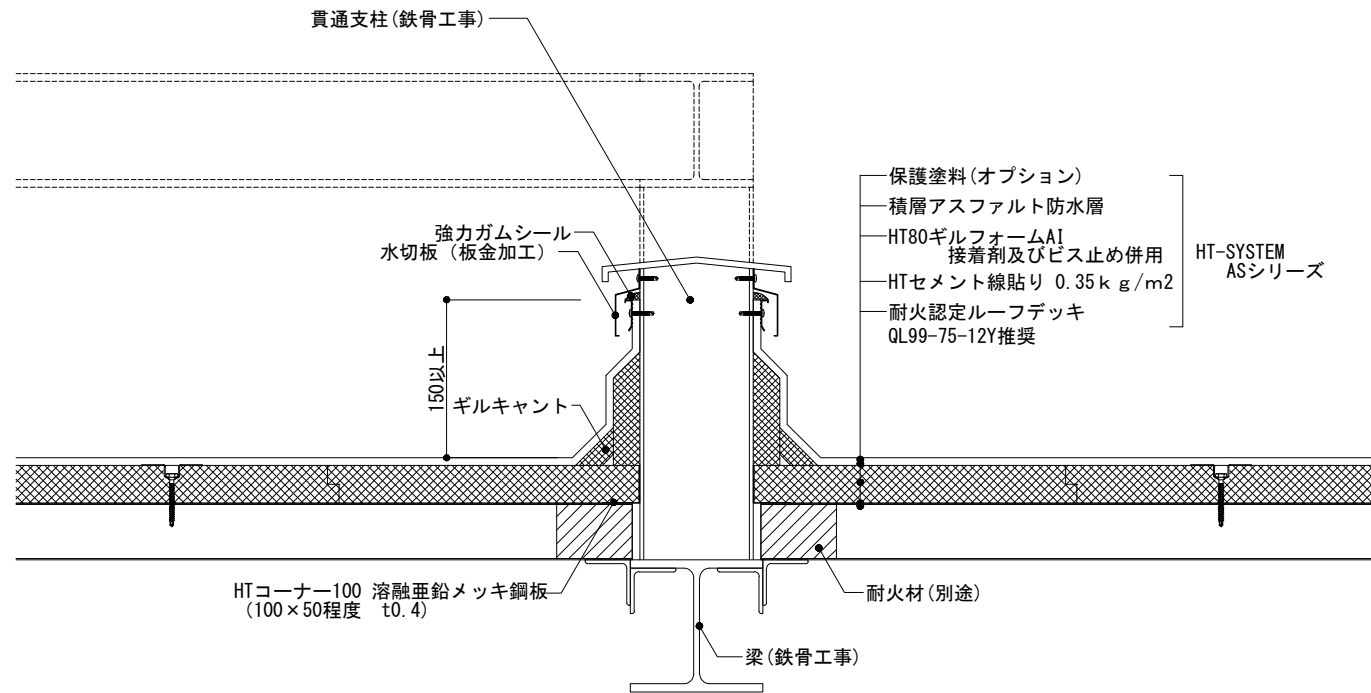

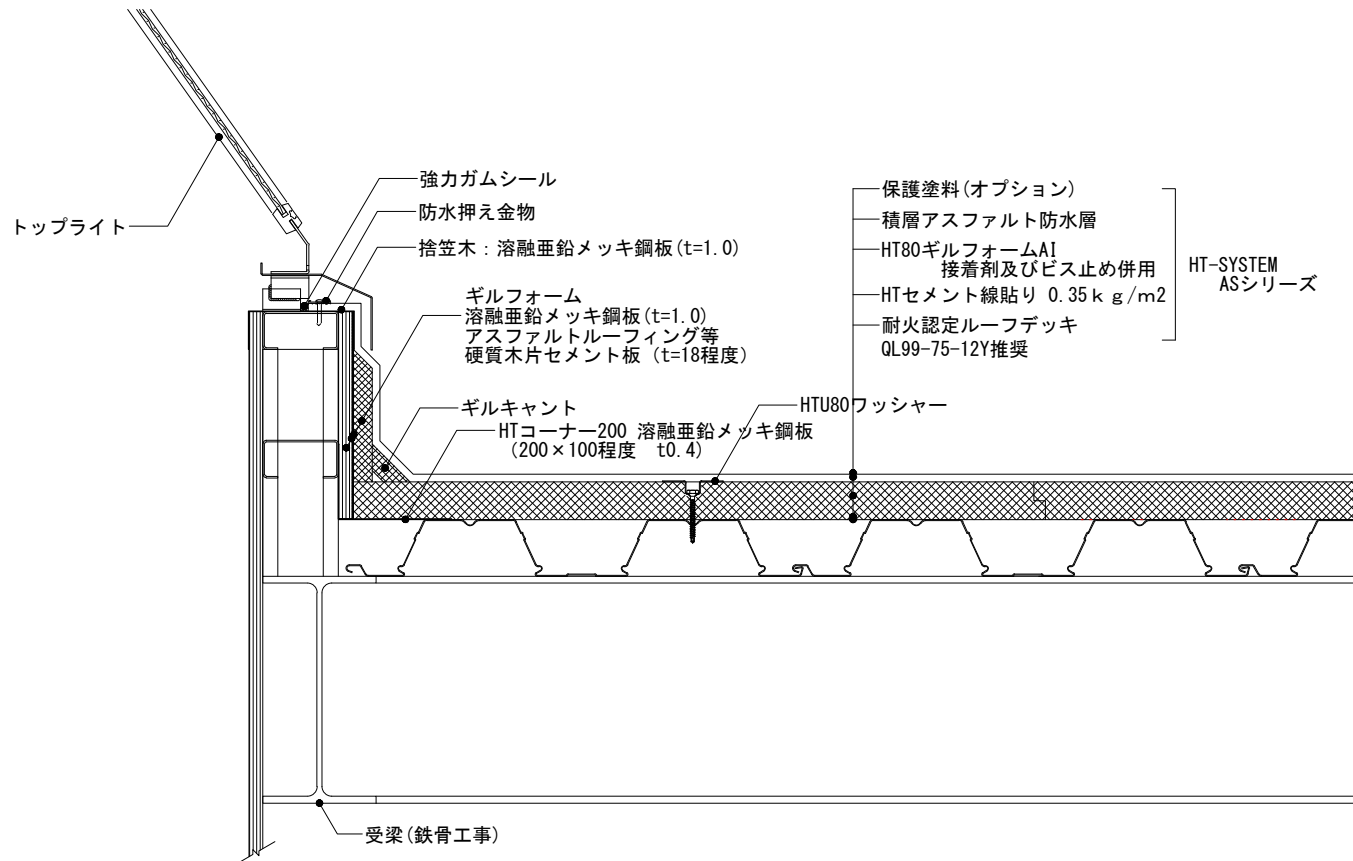

鋼製下地断熱防水 DIP S / HT 構法 模式図

dhtas-9-1

1/20 (A4)

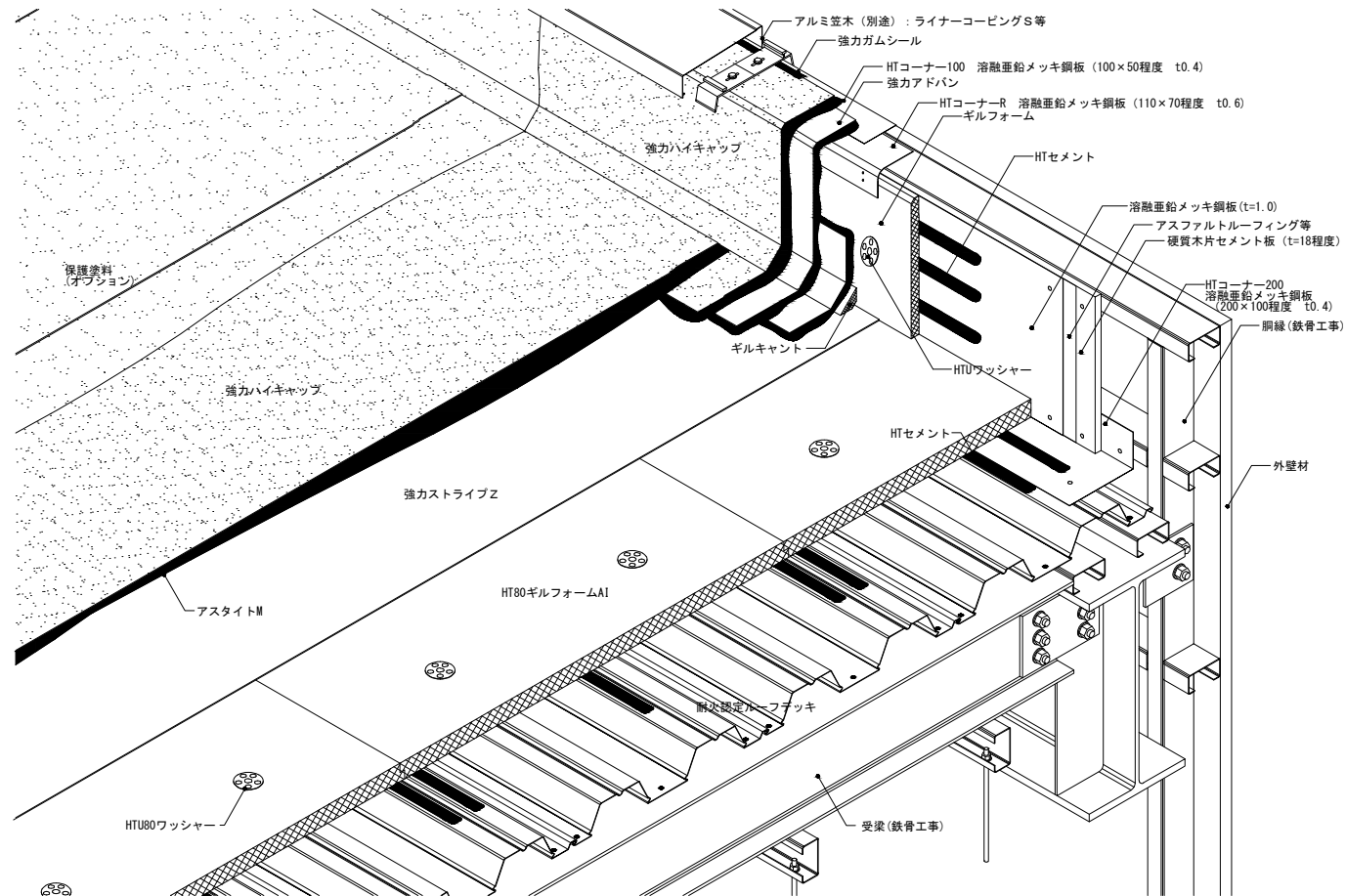

鋼製下地断熱防水 DIP S / HT・AS-HP 構法

パラペット 桁方向 / 鉄骨立上り

dhtashp-1-1

1/10 (A4)

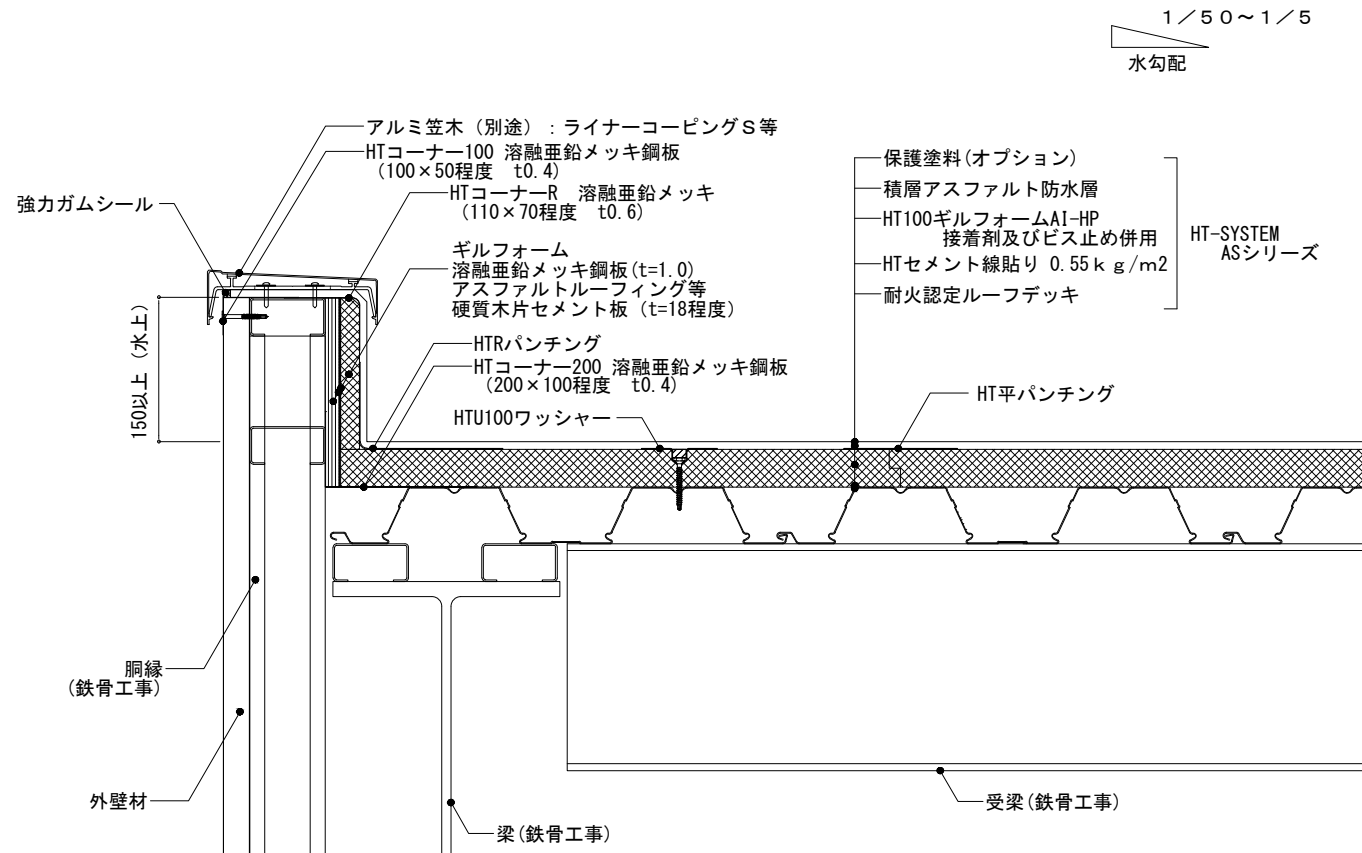

鋼製下地断熱防水 DIP S / HT 構法

パラペット 流れ方向 / 鉄骨立上り

dhtashp-1-2

1/10 (A4)

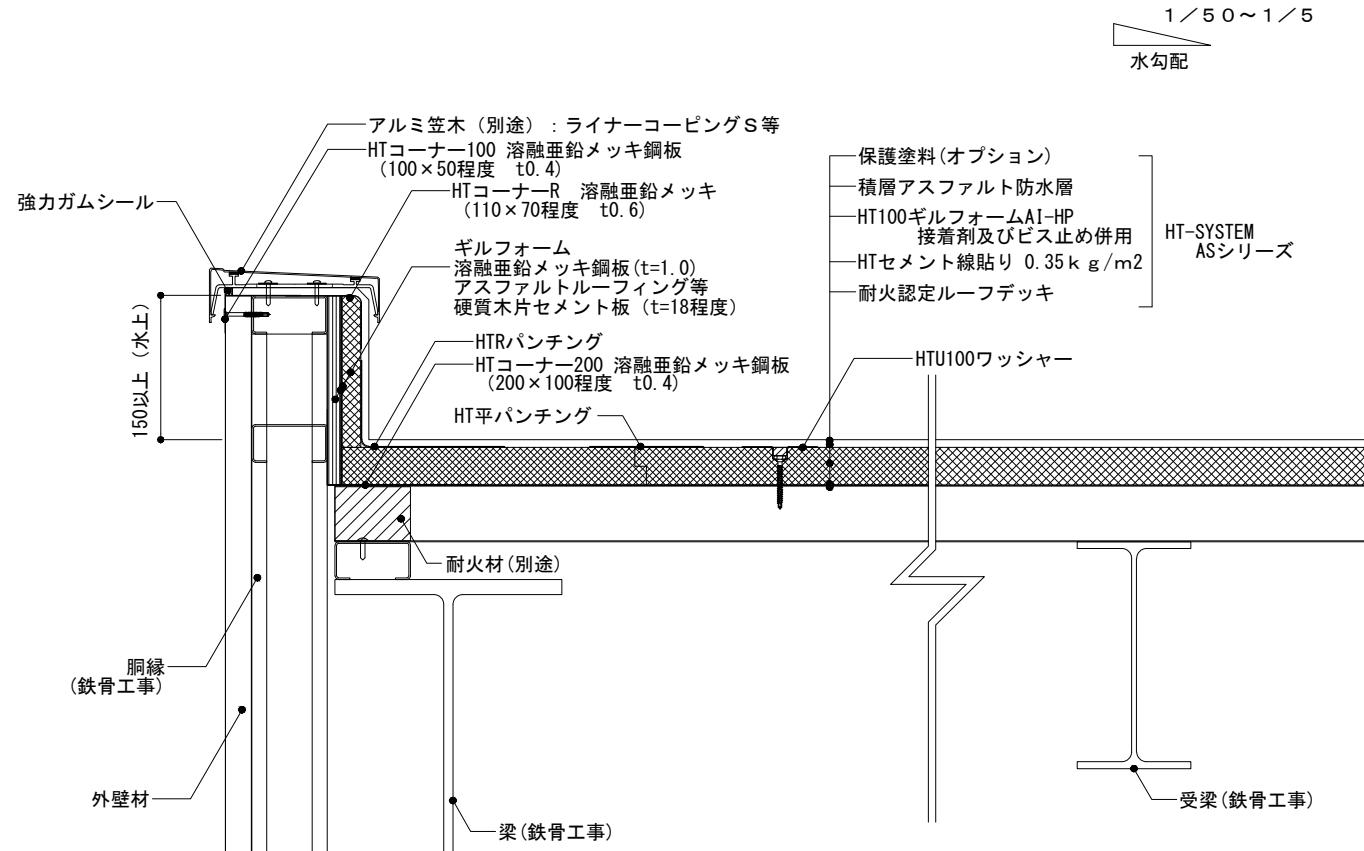

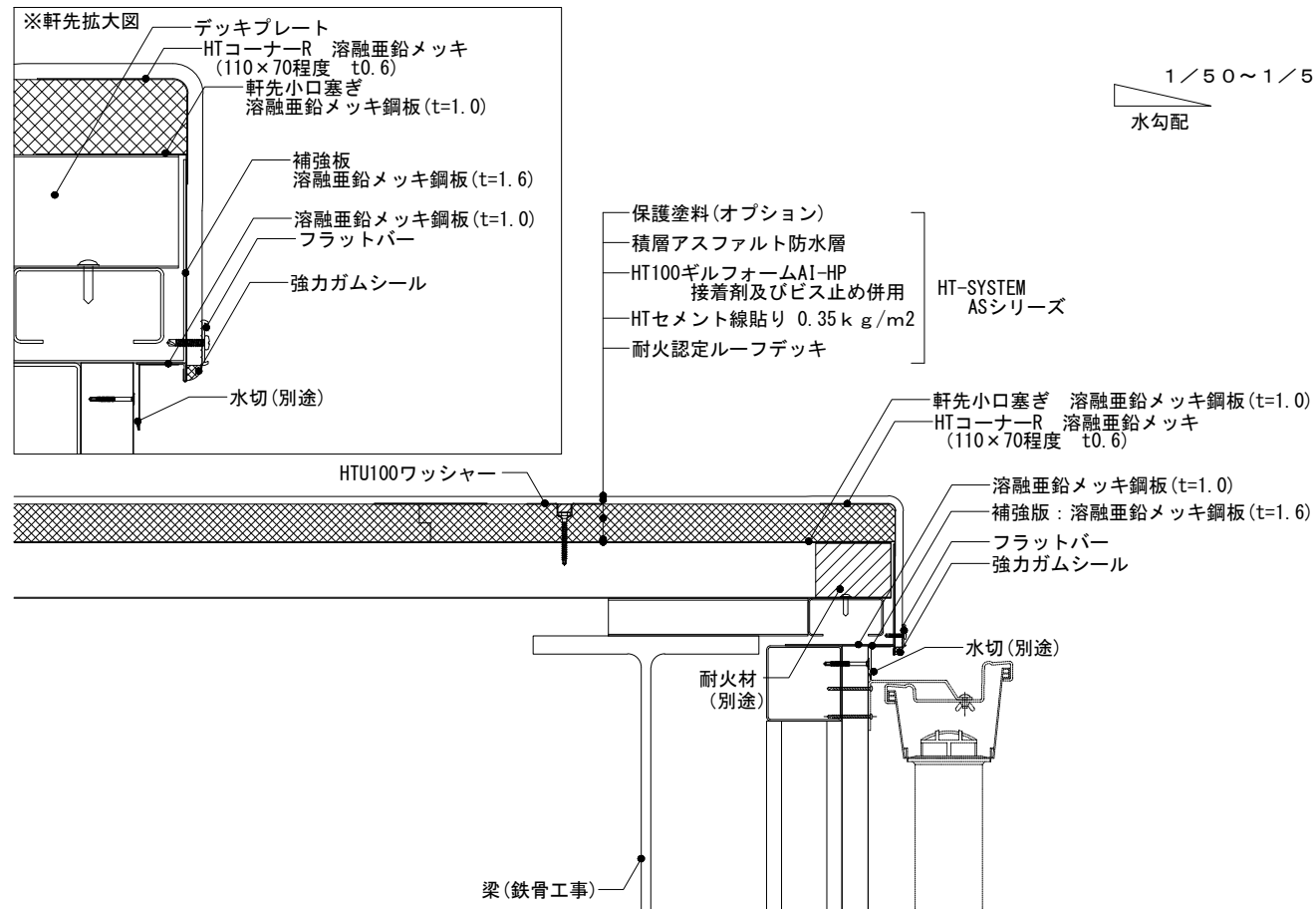

鋼製下地断熱防水 DIP S / HT 構法

壁立上り / ALC立上り

dhtashp-1-4

1/10 (A4)

